



# TRELLIS POSTS TECHNICAL SUPPORT

## PACKAGING:

Domestic packaging:

3 nylon straps + 2 nylon slings for each bundle.



Export packaging. (lengths less than 2350mm):

3 nylon straps + 2 nylon slings for each bundle.

Each group of 4 bundles is held together by metal straps and supported by grooved and treated wooden sticks.

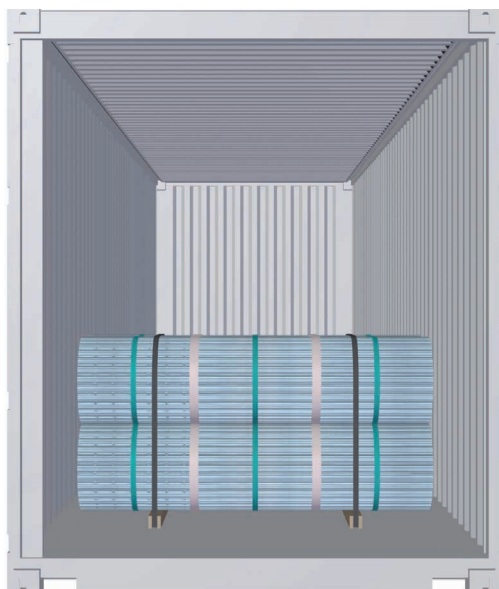
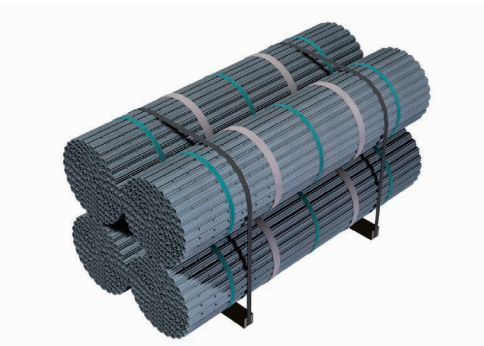

Export packaging. (lengths greater than 2350mm):

3 nylon straps + 2 nylon slings for each bundle.

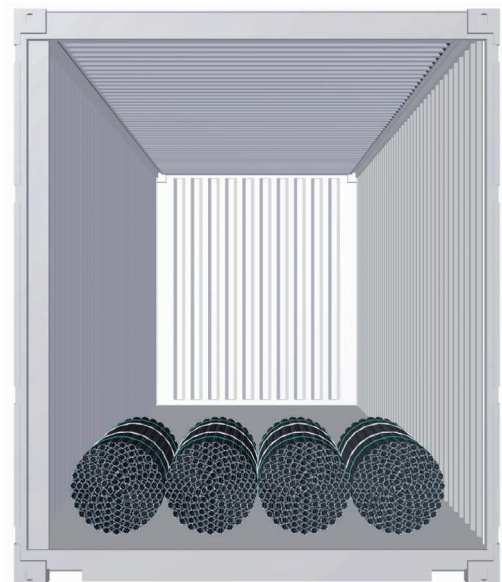
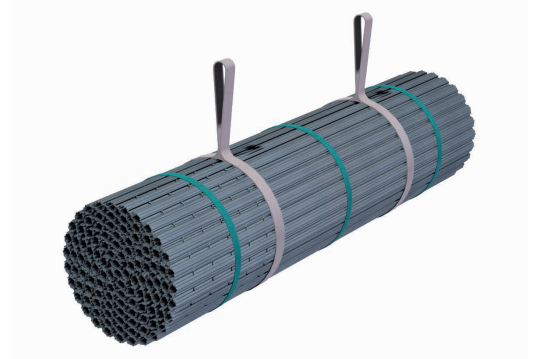

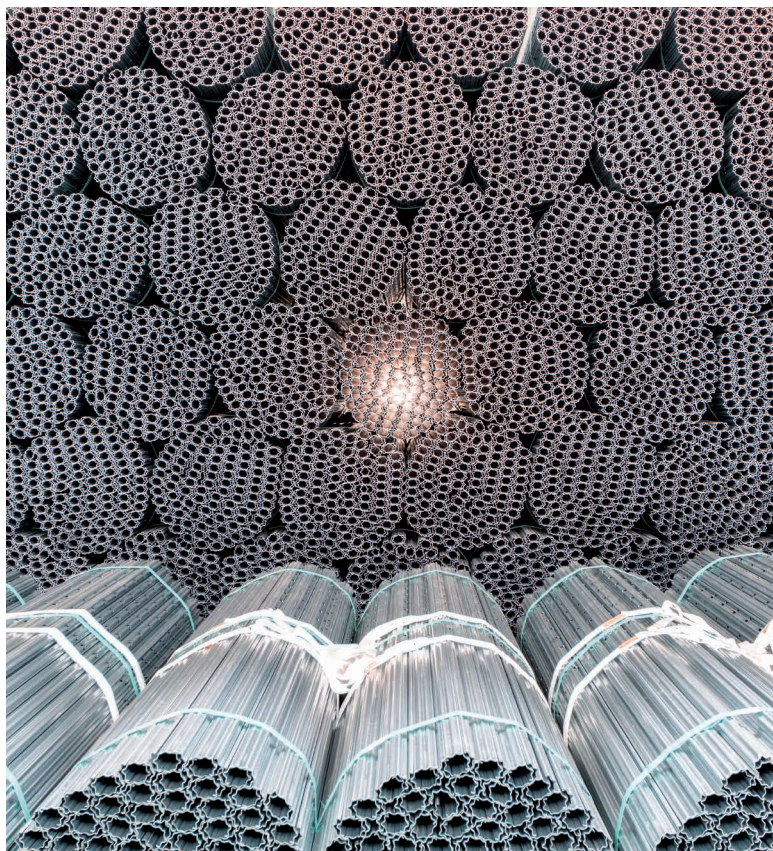

## STORAGE:

We recommend storing the bundles in a dry and covered place, avoiding contact with water or humidity while they are still strapped. If the bundle gets wet by accident, it is advisable to undo it and separate the posts to dry.

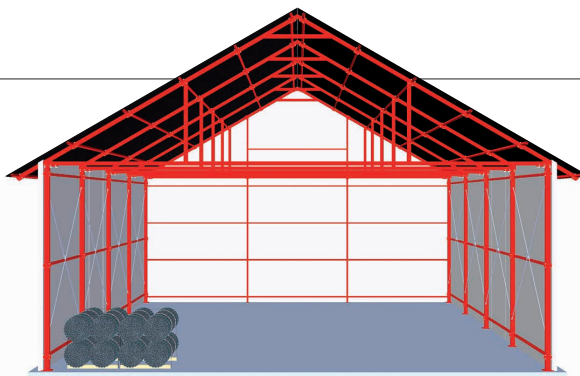

## HANDLING:

The bundles must only be handled by supporting them by the nylon slings enabled for this purpose. For safety reasons, under no circumstances should the bundles be supported by the tie straps.

In the Export packaging at  $< 2350\text{mm}$ , each set of 4 bundles must be handled by forklift until all 4 bundles are separated.

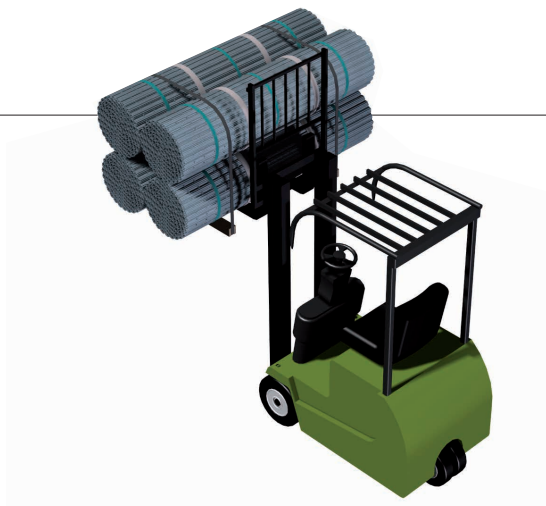



[magontrellis.com.au](http://magontrellis.com.au)

[info@magontrellis.com.au](mailto:info@magontrellis.com.au)  
+61 0 448 532 442

---

This document is not a safety manual.

The content and recommendations in the catalogue are informative and non-binding.

**MAGON METALES PERFILADOS S.A.** reserves the right to modify the contents of this document without prior notice.

General Sales Conditions available on our website [www.magon.es](http://www.magon.es)